

Integrated Industrial Solutions



melschire Automation Technologies LLC

Umm Al Quwain – UAE, Post Box: 4874. Tel: (00971 6) 7681017,
Mob: 00971 55 4361078, Fax : (00971 6) 7681027.
www.melschire.com. Email: info@melschire.com.



Instrumentation Tubes

Hydraulic Tubing
Gas line Tubing
Petro Chemical Tubing

Inch & Metric Size
Coil & straight Length
Sch-10, Sch-20, Sch-40

Available in SS-316, SS-304, Carbon Steel
(Seamless Pipe, ERW Pipe), Copper, Brass.



Compression Fittings

Double Ferrule Fitting
Single Ferrule Fitting
Compression Adaptor

Elbow, Tee, Straight
Inch & Metric size
NPT, BSP, JIC, Flair

Available in SS-316, SS-304, Carbon Steel, MS,
Copper, Brass, PE, Teflon. (also custom made)



Fitting & Adaptor

High Pressure Fittings
Hydraulic Fittings
Pipe Fittings

Test Point Fittings
Banjo Fittings

Available in MS, CS, SS316, SS304, GI, Brass, Copper,
Teflon Material (also custom made)



Pneumatic Fittings & Tubes

FRL
Solenoid Valve
Cylinder & Fittings
QRC (Ludecke & Milton)
One Touch & Push Fitting
(Plastic, Metal, Brass)

PU Tube
PU Spring Coil
Nylon Tube
Silicon Tube
Teflon Tube
Inch & Metric Size



Vacuum

Vacuum Cup in Flat,
Bellow, Normal (NBR,
SBR, Silicon)

Vacuum Generator
Vacuum Ejector
Vacuum Gage (Dry &
Liquid Filled)



Melschire Automation Technologies LLC

Umm Al Quwain – UAE, Post Box : 4874. Tel : (00971 6) 7681017

Fax : (00971 6) 7681027. www.melschire.com. Email : info@melschire.com

Hose

Hydraulic Hose
 Steam Hose
 Chemical Hose
 Food Hose
 Sandblast Hose
 SS Corrugated Hose
 SS Metallic Hose
 GI Metallic Hose
 PVC Green Hose
 Olive Green Hose
 Radiator Hose

Air Hose
 Water (suction & discharge)
 Oil (suction & discharge)
 Cement Hose
 Bulk Material Hose
 SS Braided Teflon Hose
 Reinforced PU Hose
 Transparent PU Hose
 Lay Flat Hose (Mid & HD)
 Synthetic Fire Hose
 Duct Hose (PU, Gry, EPDM)



Crimping & Assembling Facility (custom made)

Clamps

Jubilee Type
 Worm Type
 SBSC Type
 Stuff Type Single
 Stuff Type Double

Double Bolt
 Four Bolt
 Up to 30mtr Strip
 Hanging Type
 Nail Type



Available in MS, SS, GI Material (also custom made)

Bellows

Rubber Expansion Bellows
 Union Type & Flange Type

SS Bellows
 SS Corrugated Bellows

Available in Customer Requirement



Couplings & Elements

Miller Coupling
 Shortz Coupling
 Chicago Coupling
 Victaulic Coupling
 Cam Lock Coupling

HRC, Lovejoy
 Fenner, Rotex
 Grid Coupling
 Aluminum Coupling
 Tire Coupling

All Coupling Elements & Gasket Available

Melschire Automation Technologies LLC

Umm Al Quwain – UAE, Post Box : 4874. Tel : (00971 6) 7681017
 Fax : (00971 6) 7681027. www.melschire.com. Email : info@melschire.com.

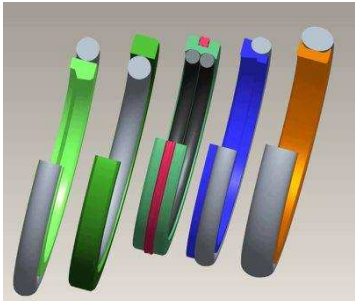

Hydraulic Seals

| | |
|------------------|-------------|
| Hydraulic U Seal | Piston Seal |
| Guide Ring | V Pack |
| Road seal | Wiper Seal |

Available in PU, NBR, SBR, Teflon, Gray Teflon, Silicon, Viton, UHME, Fiber Material (also custom made)



O Rings

| | |
|-------------|-----------|
| O Ring | Flat Ring |
| O Ring Cord | X Ring |

Available in PU, NBR, SBR, Teflon, Silicon, Viton, Material (also custom made)



Oil Seal

| | |
|---------------------|-------------|
| Single Lip Oil Seal | Closed Type |
| Double Lip Oil Seal | Wiper Type |

Available in NBR, Silicon, Viton, Metal Type, Teflon Type (also custom made)



Mechanical Seal

| | |
|----------------------|---------------------|
| Water Pump Seal | Rotary Union Seal |
| High Speed Pump Seal | Grundfose Pump Seal |
| Chemical Pump Seal | Ebara Pump Seal |

Available in Ceramic, Carbon, Silicon Carbide, Teflon, SS Silicon Carbide, (we are specialized in custom made)

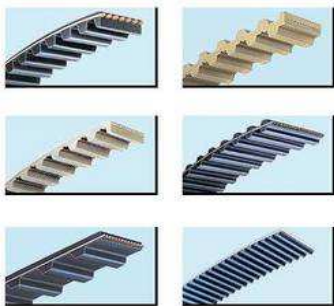
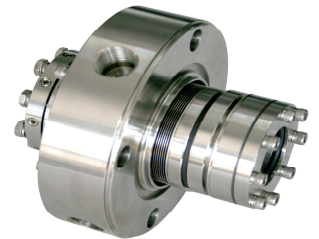

Belt

| | |
|-----------------------------|------------------------|
| V Belt | Food Conveyor Belt |
| X Belt | Printing Conveyor |
| SPA, B, C, D Belt | Packaging Conveyor |
| Timing Belt "HTD" | General Conveyor |
| Endless Timing Belt H, M, L | Specially Fabricated- |
| End Timing Belt T, AT, M, L | Conveyor & Timing Belt |

Available in PU, Canvas, Teflon, Silicon, SS, Rubber Materials in Difference Size and Pitch (also custom made)

Melschire Automation Technologies LLC

Umm Al Quwain – UAE, Post Box : 4874. Tel : (00971 6) 7681017
 Fax : (00971 6) 7681027. www.melschire.com. Email : info@melschire.com.



Valve

- | | |
|-----------------|----------------|
| Ball Valve | Knife Valve |
| Gate Valve | Needle Valve |
| Globe Valve | Manifold Valve |
| Butterfly Valve | Mini Valve |

Available in MS, SS, Brass, Bronze, Teflon, PE Material (also in Motorized, Pneumatic Actuator custom made)



Nut, Bolt

- | | |
|----------------|------------------------|
| Hex Bolt | Wings Nut Bolt |
| Allen Bolt | Lock Nut, Anchore Bolt |
| Machines Screw | Tie Bolt |

Available in MS,SS, CS, Cadmium, Brass, Teflon Material (also custom made)

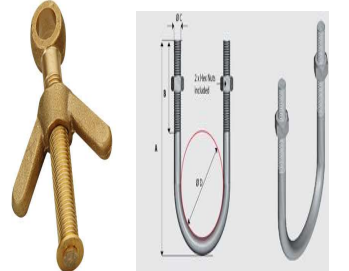

Washer, Circlip

- | | |
|---------------|------------------|
| Plate Washer | Internal Circlip |
| Spring Washer | External Circlip |
| Star Washer | Snap Rings |
| Copper Washer | Aluminum Washer |

Available in MS, SS, GI, Teflon, Rubber, Silicon Material (also custom made)



Bearings

- | | |
|----------------|----------------------|
| Ball Bearing | Tapper Bearing |
| Needle Bearing | Linier Guide Bearing |
| Trust Bearing | Ball Screw Bearing |
| Pillow Bearing | Eye End Bearing |

Available in all Major Brands (also custom made)



Gasket, Rubber Mounting

- | | |
|---------------------|------------------------|
| Non-Asbestos Gasket | Single Bolt Mounting |
| Graphite Gasket | Double Bolt Mounting |
| Metallic Gasket | As per Sample Mounting |

Available in Sheet & Any Type of Customer Requirement



Melschire Automation Technologies LLC

Umm Al Quwain – UAE, Post Box : 4874. Tel : (00971 6) 7681017
 Fax : (00971 6) 7681027. www.melschire.com. Email : info@melschire.com.

Industrial Automation

Project Work & Maintenance

Water Treatment Plant
Food Processing Plant
Petro Chemical Plant
Printing Industries
Packaging Industries
Plastic Industries
Wood Industries
Hotels and Airport Service Area
Custom Related Modification & Fabrication

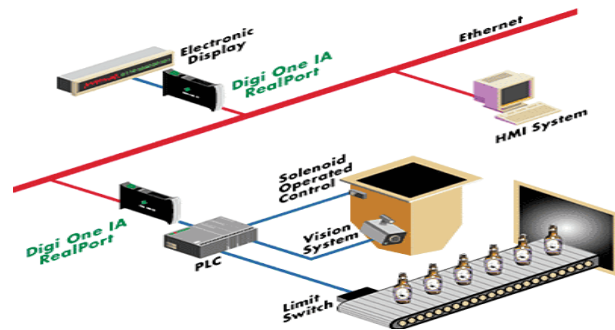
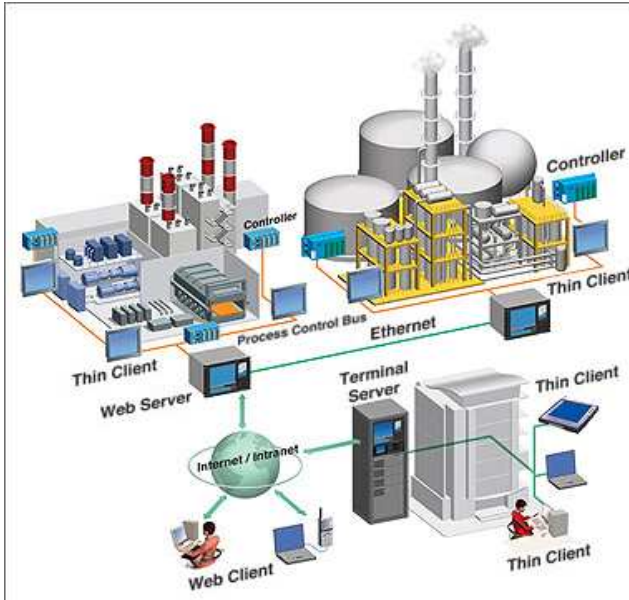

Technical Service

Mother Board based Service
Integrated Chip (uBGA) based PCB Repair
Electronic based Modification
PLC, HMI based Plant Up gradation
Manual, Semi-Auto Machine Up gradation
Supervisory data Access Control based Plant Monitoring
PC based Plant Supervising with Accounting Inventory

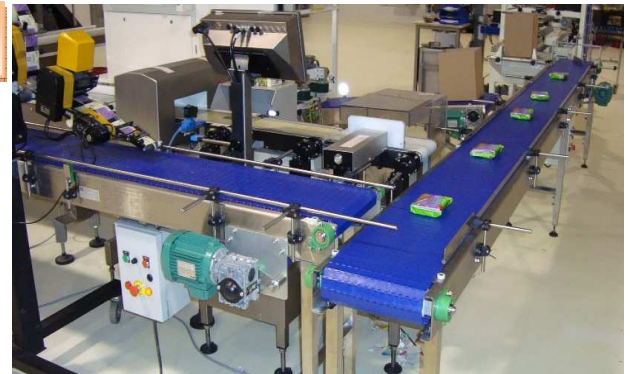

Melschire Automation Technologies LLC

Umm Al Quwain – UAE, Post Box : 4874. Tel : (00971 6) 7681017
Fax : (00971 6) 7681027. www.melschire.com. Email : info@melschire.com.

Mechanical Solution for Industry

Fabrication for Mechanical Parts
Modification for Mechanical Parts
Fabrication of Gear in Teflon, UHME, Fiber, Brass, MS, SS
Fabrication of Conveyor Systems for any type Industry
Fabrication of High Pressure Fittings in MS, SS



All Type of Mechanical, Engineering, Fabrication, Instrumentation Work Will Be Done



Custom made Parts in UHME, Teflon & Silicon

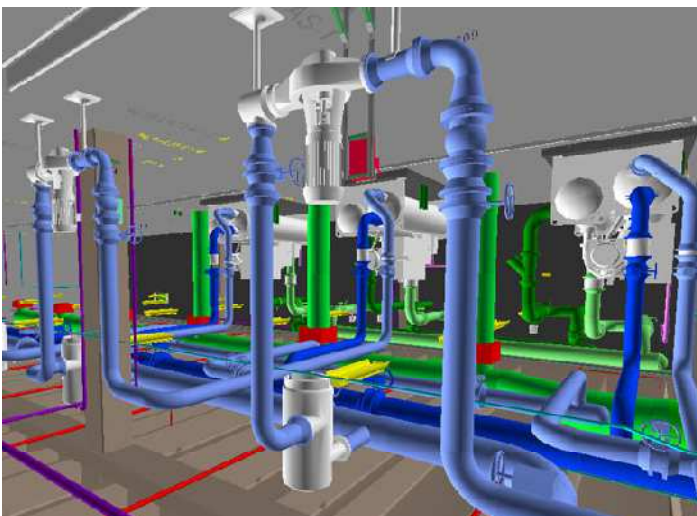

Melschire Automation Technologies LLC

Umm Al Quwain – UAE, Post Box : 4874. Tel : (00971 6) 7681017

Fax : (00971 6) 7681027. www.melschire.com. Email : info@melschire.com

Chemical



Degreasing, Cleaning, Dismantling



Rust-removing Cleaner (very quick action)
Universal Lubricant-Degrease (non-inflammable)
Non-Inflammable Safety, Handy Seize Product
Orange Releasing Agent
WR+: 5 Product Over 1000 Uses
Super Industrial Degreaser
Orange Solvent
Degreaser for Tar, Grease, Oil, Adhesive and Paints
Highly Concentrated Detergent Cleaner
Food Industry Cleaner
Shampoo for Car Body
Specially designed for cleaning all type of Rims
Liquid Drain Renovator for Pipe unblocking
Scale Remover (powerful cleaner for Tiles & Joints)

Re-Assembling & Lubricating

Molspray (Dry Lubrication for Small Mechanism)
Tefliss 2 (PTFE based Clean and Dry Lubricant)
Pate Spray (Lubrication of Tools, Assemblies and Mechanical Parts)
HT 600 (Handy Corrosion Lubricants for parts subjected to bad weather)
TM 900s (High Temperature Copper based Lubrication)
CT 10 (Multy Purpose Lithium based Grease)
CT 12G (Graphite based Lithium Grease for Low Friction)
CT FLON (Lithium and Teflon based Multipurpose grease)
WSA (Marine Grease)
CT 609 (Grease for Food Industry)
SI 4 (Silicon Grease)
CB 6 (Clean Lubricant for Chains, Conveyor and Mechanism)
LUBRIFIANT HP (High Temperature and Chemical Environment Grease)
Silicon Spray (mould release agent for Rubbers and Plastics)



Melschire Automation Technologies LLC

Umm Al Quwain – UAE, Post Box : 4874. Tel : (00971 6) 7681017

Fax : (00971 6) 7681027. www.melschire.com. Email : info@melschire.com.

Chemical



Treaded Lock, Sealing, Bonding



- 298 (Treaded Lock for Food Industry)
- 303 (Medium Strength locking for Threaded Parts)
- 300 (Permanent Locking for Threaded Parts)
- 507 NDI (Dry Solvent for Surfaces Preparation)
- 318 (Locking for Retaining Parts eg. Bearing, Sleeve)
- 316 (Locking for Bushes, Bearing, Sleeves, Pulley)
- 310 (Very High Dynamic Strength Locking)
- 133 (Plastic Threaded Sealing – Hot and Cold water)
- 340 (Sealing Paste with PTFE Resistance to Vibration)
- 329 (Medium strength Liquid Gasket)
- 367 (Seals Threaded Pipe and Connection)
- 331 (Teflon based Gasket for Hydraulic Connection)
- 342 (Flexible Sealant for Treaded Parts face Joints)
- 104 (Black Silicon Gasket for all Sealing Sumps, Doors)
- 103 (High Temperature Flexible Sealing and Bonding)

Protection and Detection

- Medium Term Anti Corrosion Protection
- Long Lasting Protection for Storage Parts
- Cold Galvanizing
- Powerful Rest Stop Converter
- Increases Drive Belt Adhesion
- Welding Anti-Adhesion (spatter for nozzle, gages)
- Special Protect based on Ceramic for Nozzle Protection
- Leak Detector for Gas or Compressed Air
- Dry Solvent for Crack Detection
- Penetrating for Crack Detection
- Chlorine free Micro Emulsion for Machining Purpose
- Heavy Duty Cutting Oil
- Cleaning Solvent for Electronic Parts
- Insulating Varnish for High Voltage
- Cleaner for Window Surfaces (monitor, over head projector, copier)
- Citrus Fruits Hand Care Degreaser
- Water free Cleaner for Hand Hygiene



Melschire Automation Technologies LLC

Umm Al Quwain – UAE, Post Box : 4874. Tel : (00971 6) 7681017

Fax : (00971 6) 7681027. www.melschire.com. Email : info@melschire.com.